

PRODUCT
CATALOG

2024



THE ILLUMICARE Advantage

Illumicare Group Limited is a leading manufacturer and supplier of landscape LED lighting products. Created as a response to the increased demand for LED lighting solutions, Illumicare is dedicated to delivering market-driven products using cutting-edge LED technologies.

Research & Development

Our in-house R&D team believes in continuous innovation and implements the latest in LED technologies. We develop with environmental stewardship in mind and design our products to maximize energy savings, reduce maintenance costs, enhance safety measures, and reduce light pollution. Illumicare aims to deliver innovative LED lighting systems with advanced engineering and artistic appeal.

Quality

Our products go through rigorous testing to surpass industry standards and withstand harsh outdoor environments. We proudly stand behind our products and confidently offer warranties against workmanship and manufacturing defects.

Shipping Commitments

With two distribution centers ready to fill your order, Illumicare offers same or next-day shipping on most in stock orders placed before 10:00 AM (EST) shipping within the US & Canada.

Support

We're committed to both our products and our customers. With over 50 years of combined experience, our Lighting Professionals can offer you expert advice and help you with any questions or concerns.



Connect with us:



Toll Free: 1-866-277-2934

Fax: 1-800-559-1806

illumicaregroup.com

sales@illumicaregroup.com

CONTENTS



Landscape Lighting Techniques	4
LED Lamps	6
Miniature LED Lamps	8
Solid Brass Outdoor Fixtures	10
Precision Engineered Luminaires	22
In-ground Luminaires	30
NEW Symphony Hardscape Luminaires	32
Contrast Fixtures	36
Smart Home	38
Transformers	41
Accessories	44
Warranty	46

INNOVATE | INTEGRATE | ILLUMINATE

LANDSCAPE LIGHTING **Techniques**

Outdoor lighting can dramatically transform landscapes by providing safety, security, accent, and character. Just a few well-placed lights can have an enormous impact. However, poorly designed lighting systems can result in glare and over illumination leading to wasted energy, money, and resources.

Illumicare fixtures are available in different finish options, are easily adjustable, and have glare-control properties. We also offer LED lamps in four color temperatures and varying beamspreads to help you increase your lighting palette.

Here are some of our favorite lighting effects to help you create beautiful outdoor lighting systems.

Shadowing

Highlight an interesting shape or structure by projecting its shadow onto a vertical surface.



Wall Washing

Create a soft glow over a wall or vertical surface by bathing it with light, resulting in ambient lighting for the surrounding area.



Accent Lighting

Illuminate a landscape feature by specifically angling an uplight or downlight to draw special attention to it.



Underwater Lighting

Amplify a water feature by highlighting it underwater. Underwater lighting can create interesting shadows, reflections, and atmospheric effects.

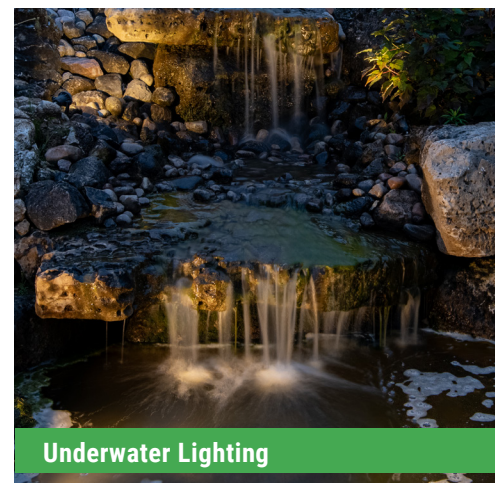



Silhouetting & Backlighting



Grazing

Silhouetting & Backlighting

Present a dark outline of an object by placing a light source behind the feature, aimed at a vertical surface behind it.

Grazing

Emphasize a textured surface by aiming a paralleled light source, casting delicate shadows.



Step Lighting

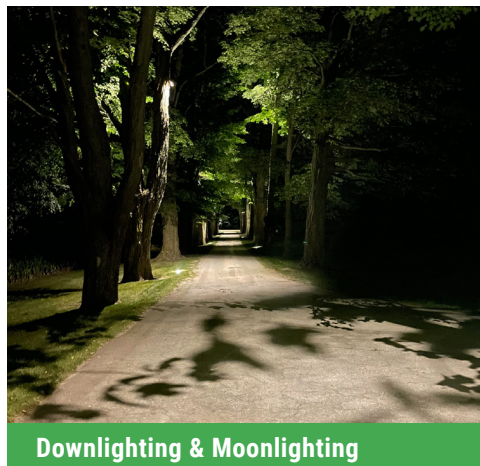

Downlighting & Moonlighting

Step Lighting

Accent steps using recessed lighting or coping lights. Step lighting provides safety and a warm atmosphere.

Downlighting & Moonlighting

Mount fixtures high in a tree, aimed downward to mimic the effect of moonlight.



Uplighting



Path & Area Lighting

Uplighting

Highlight an architectural design by illuminating it from below. Aim the light source toward a feature to create a bold focal point.

Path & Area Lighting

Place fixtures along the borders of walkways, driveways, and patios to create low-level illumination and nighttime visibility.

LED Lamps

LED lamps use ~85 percent less energy than traditional lamps and last roughly 15 times longer, using less energy for the same light output.

Illumicare's fully-stepped LED IC driver and unique thermal engineering ensures the lamps operate at temperatures below the LED chips' heat specifications, even when sealed inside weatherproof fixtures. By removing the electrolytic capacitor and completely encapsulating the IC chip in thermal epoxy, we've designed outdoor-rated LED lamps that produce up to 40% less heat in airtight fixtures and more than doubled the chip's life expectancy.

- Conventional lamp shapes
- Fully-stepped IC driver
- Completely encapsulated driver
- Unique thermal control
- Consistent lumen output
- Over-current protection
- Reversed polarity protection
- Full-solid state components



LED Lamp Performance Data	
Input Voltage	12 V AC or DC (9 - 15V AC/DC)
Operating Temperature	35 - 40°C (95 - 104°F)
Operating Environment	-20 to 40°C (-4 - 104°F)
Lamp Surface Temperature	Less than 35°C (95°F)
Lumen Maintenance (L70)	40,000 Hours
Color Rendering Index (CRI)	79-85%
Product Standards	CE & ROHS

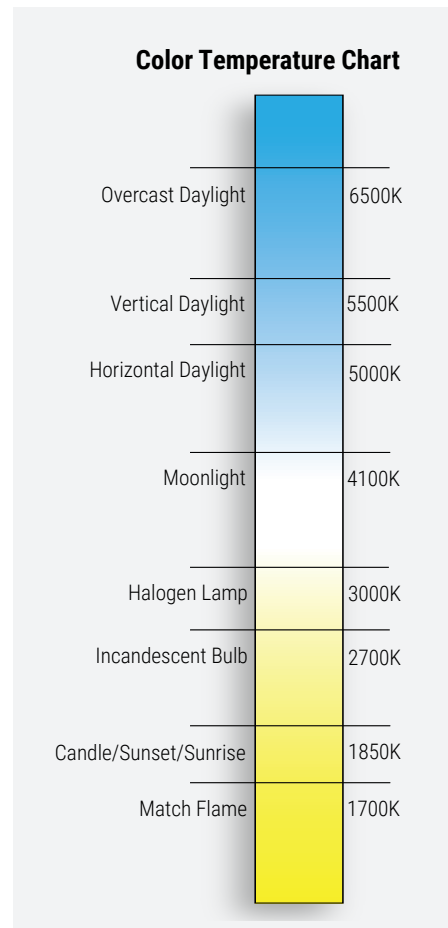

LED MR16 SINGLE LENS WITH REPLACEABLE OPTICS



Illumicare's newest MR16 single lens lamp includes four replaceable optics, giving you the ultimate flexibility of 4 beam spreads in one box! Easily replace the collimator by unscrewing the face of the lamp to install your choice of 15, 30, 45 or 60-degree collimators.

Part Number	Description
LED MR16 5W 2700K	Very Warm White 5W MR16 Lamp
LED MR16 5W 3000K	Warm White 5W MR16 Lamp
LED MR16 5W 4000K	Neutral White 5W MR16 Lamp
LED MR16 7W 2700K	Very Warm White 7W MR16 Lamp
LED MR16 7W 3000K	Warm White 7W MR16 Lamp
LED MR16 7W 4000K	Neutral White 7W MR16 Lamp

Specifications

- 220-250 Lumens (5W Lamp)
- 450-510 Lumens (7W Lamp)
- GU5.3/GX5.3 Bipin Base
- 1 Cree LED chip

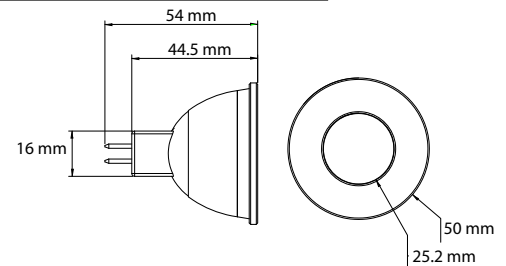

LED MR11 WITH REPLACEABLE OPTICS



The LED MR11 now features replaceable optics for four different beam spreads. Simply use the supplied tool to remove the face of the lamp and replace the installed optic with your choice of 15, 30, 45 or 60 degrees.

Part Number	Description
LED MR11 VWW-1560	2700K very warm white
LED MR11 WW-1560	3000K warm white
LED MR11 NW-1560	4000K neutral white

Specifications

- 4W output
- Factory-installed 30° NFL optic, and 15°, 45° & 60° optics w/install tool
- 220-250 Lumens
- GU10/GZ10 Base
- 1 Cree LED chip

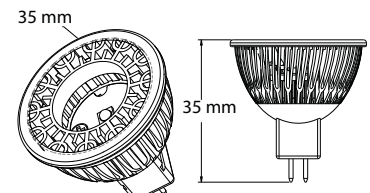

MINIATURE LED Lamps

Illumicare's miniature LED lamps provide seamless replacement for incandescent or halogen miniature bulbs.

- Color Temperature: 2700K & 3000K
- 1.5-3 Watt Output
- 15-18 Watt Equivalent
- Samsung 5630 LED Chips

Base & Lamp Types

S8 Wedge - 3155 & 3156
 G5.3 BiPin - Q20 & Q35
 G4 BiPin - Q10, Q15 & Q20
 SCB - 93, 1141 & 1156
 T5 Wedge - 912, 918 & 921



LED Lamp Performance Data

Input Voltage	12 V AC or DC (9 - 15V AC/DC)
Operating Temperature	35 - 40°C (95 - 104°F)
Operating Environment	-20 to 40°C (-4 - 104°F)
Lamp Surface Temperature	Less than 35°C (95°F)
Lumen Maintenance (L70)	35,000 Hours
Color Rendering Index (CRI)	79-85%
Product Standards	CE & ROHS

LED G5.3 BIPIN



5 YEAR
Warranty

Part Number

LED G5.3 BIPIN 2700K

LED G5.3 BIPIN 3000K

Specifications

- Replaces: Q20 & Q35
- 230 Lumens
- 2.5 Watts
- 24 mm x 40.5 mm
- 12 LED chips
- omnidirectional illumination

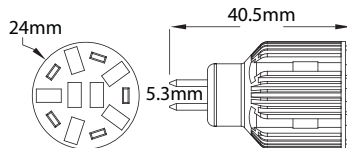

LED SCB



5 YEAR
Warranty

Part Number

LED SCB 2700K

LED SCB 3000K

Specifications

- Replaces: 93, 1141 & 1156
- 260 Lumens
- 3 Watts
- 24 mm x 46 mm
- 14 LED chips
- omnidirectional illumination

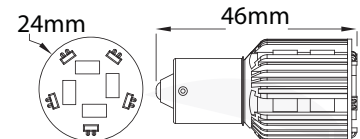

LED 19MM G4 BIPIN



5 YEAR
Warranty

Part Number

LED G4 BIPIN 2700K

LED G4 BIPIN 3000K

Specifications

- Replaces: Q10, Q15 & Q20
- 190 Lumens
- 1.8 Watts
- 19 mm x 31.5 mm
- 9 LED chips
- omnidirectional illumination

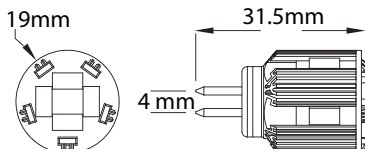

G4 MINI



5 YEAR
Warranty

Part Number

LED G4 MINI 2700K

LED G4 MINI 3000K

Specifications

- 1.7 Watts
- 12.4 mm x 30 mm
- 150-180 Lumens
- 4 LED chips
- omnidirectional illumination

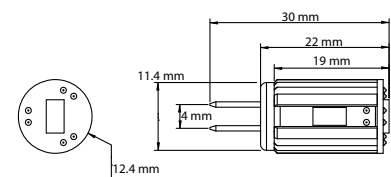

LED 19MM T5 WEDGE



5 YEAR
Warranty

Part Number

LED T5 WEDGE 2700K

LED T5 WEDGE 3000K

Specifications

- Replaces: 912, 918 & 921
- 210 Lumens
- 1.8 Watts
- 19 mm x 39 mm
- omnidirectional illumination

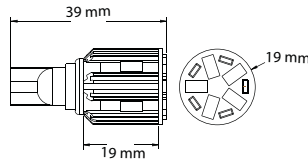

T5 MINI



5 YEAR
Warranty

Part Number

ED T5 MINI 2700K

LED T5 MINI 3000K

Specifications

- 1.7 Watts
- 12.4 mm x 31 mm
- 150-180 Lumens
- 4 LED chips
- omnidirectional illumination

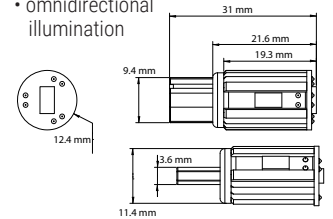

LED BP REAR



5 YEAR
Warranty

Part Number

LED BP REAR 2700K

LED BP REAR 3000K

Specifications

- 125 Lumens
- 1.6 Watts
- 14 mm x 22.8 mm
- unidirectional illumination

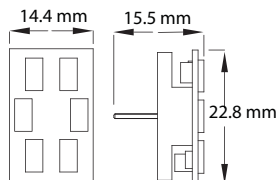

LED BP SIDE

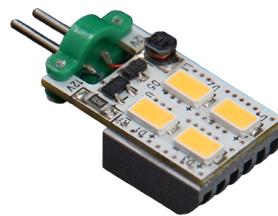

5 YEAR
Warranty

Part Number

LED BP SIDE 2700K

LED BP SIDE 3000K

Specifications

- 125 Lumens
- 2 Watts
- 14.2 mm x 31.5 mm
- Pin base rotates up to 45°
- unidirectional illumination

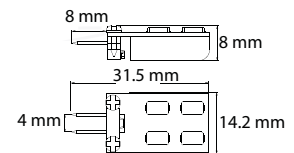

LED S8 WEDGE



5 YEAR
Warranty

Part Number

LED S8 WEDGE 2700K

LED S8 WEDGE 3000K

Specifications

- Replaces: 3155 & 3156
- 260 Lumens
- 3 Watts
- 24 mm x 51.8 mm
- omnidirectional illumination

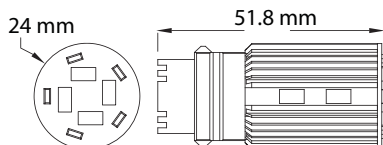

NEW RGBW



CLICK FOR SPEC SHEET

SOLID BRASS OUTDOOR Fixtures

Illumicare's solid brass fixtures are constructed of the highest quality red brass with an acid finish, giving the surface a weathered appearance. The fixtures naturally blend into the landscape while offering installed lamps optimal protection against continuous moisture and soil exposure.

Each solid brass fixture includes a minimum of 24" lead of 18/2 UL wire, a pre-greased beryllium copper socket as well as a 7" brass stake*.

*With the exception of Rowan, which includes a plastic stake.

Lamps, surface mounts and other accessories are sold separately.



Exceptional Color and Texture

No other metals create the aesthetic beauty offered by solid machined brass.



Weather Resistant

Brass has self-healing qualities that hide and blend in superficial scratches.



Low Maintenance

Brass can be restored to its original appearance even after years of neglect.



Temperature Tolerant

Brass will not soften in high temperatures or crack in low temperatures.



Corrosion Resistant

Outdoor exposure creates an attractive patina, permanently protecting the metal from corrosion.

JASPER | DIRECTIONAL LIGHT



This rugged fixture has an adjustable shroud that can easily be secured using the quick-lock set screw and silicone o-ring gaskets, ensuring a weather-tight seal to withstand harsh weather conditions. Ideal for emphasizing texture, form, and dramatic effects.

Recommended Lamp	LED MR16
Weight	2.35 lbs
Socket	Pre-greased Beryllium Copper
Wattage	Maximum 20W
Voltage	12V
Lens	Clear Tempered Glass
Includes	7" Brass Stake, 36" 18/2 UL-Rated Wire
Accessory	Honeycomb louver (sold separately)

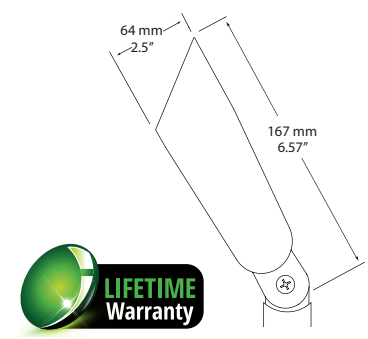

WOODY | DIRECTIONAL LIGHT



Woody can be mounted high on trellises, gazebos, and mature trees to recreate the ambiance of moonlight. Woody comes with 30' UL-listed wire for easy installation. A 10" shroud is also available and sold separately (see Accessories).

Recommended Lamp	LED MR16
Weight	2.35 lbs
Socket	Pre-greased Beryllium Copper
Wattage	Maximum 20W
Voltage	12V
Lens	Clear Tempered Glass
Includes	Brass Mount, Steel Hanger Bolt, 30' 18/2 UL-Rated Lead Wire
Accessories	10" shroud, honeycomb louver (sold separately)

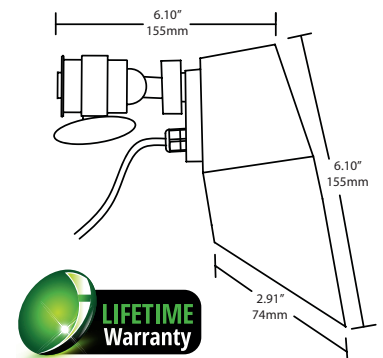

LAUREL | DIRECTIONAL LIGHT

Offered in solid brass with a weathered red brass finish, this sleek down light has an adjustable shroud making it ideal for lighting large or focused activity areas on patios, arbors, pools and paths. Laurel can be mounted high on trellises, eaves, gazebos, and mature trees.



Recommended Lamp	LED MR16
Weight	1.43 lbs
Socket	GU5.3
Wattage	Maximum 20W
Voltage	9-15V AC/DC
Includes	3' SPT-2/W 2 x 18 AWG Cable

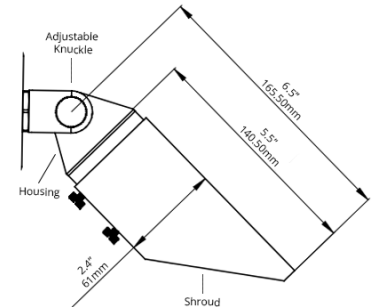

A combination of up and downlighting fixtures with MR16 LED lamps highlight the unique custom metal work on this property.

SOLID BRASS OUTDOOR Fixtures

ROWAN | DIRECTIONAL LIGHT



A compact luminaire with the flexibility of ground and surface mount all in one box. Use the bracket for downlighting applications, or ground stake for uplighting.

Recommended Lamp	MR11
Weight	1.5 lbs
Socket	Pre-greased Beryllium Copper
Wattage	Maximum 20W
Voltage	12V
Installed Lens	1/8" Flat Tempered Glass
Includes	8' 18/2 UL-Rated Wire 7" Plastic Stake
Accessories	Long Shroud, Bushing & Brass Surface Mount (each sold separately)

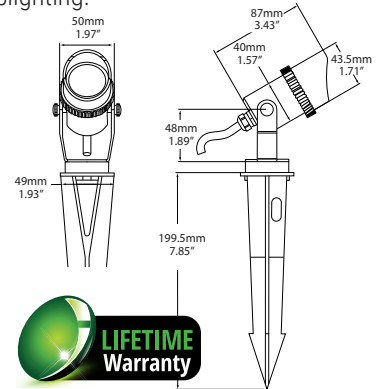

WALLY | FLOOD LIGHT



A wide wall wash ideal for illuminating walls and large vertical surfaces. Wally can be used for backlighting, silhouetting, and shadowing effects.

Recommended Lamp	LED G4 Bipin, G5.3, MR16
Weight	3.00 lbs
Socket	Pre-greased Beryllium Copper
Wattage	Maximum 20W
Voltage	12V
Installed Lens	Linear spread lens
Includes	7" Brass Stake, 36" 18/2 UL-Rated Wire, Clear & Frosted Lenses
Accessory	Honeycomb louver (sold separately)

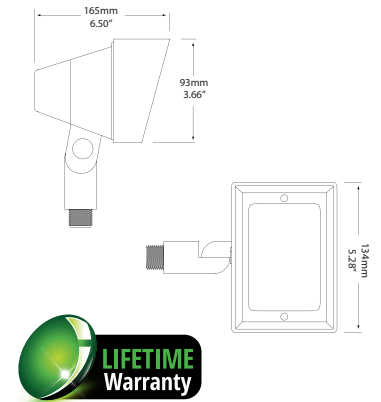

HEIDI | FLOOD LIGHT



A small brass wall wash fixture, easily hidden within small shrubs and other low foliage for creating dramatic washing, silhouetting, and shadowing effects.

Recommended Lamp	LED G4 Bipin, MR11
Weight	2.00 lbs
Socket	Pre-greased Beryllium Copper
Wattage	Maximum 20W
Voltage	12V
Installed Lens	Linear spread lens
Includes	7" Brass Stake, 36" 18/2 UL-Rated Wire, Clear & Frosted Lenses
Accessory	Honeycomb louver (sold separately)

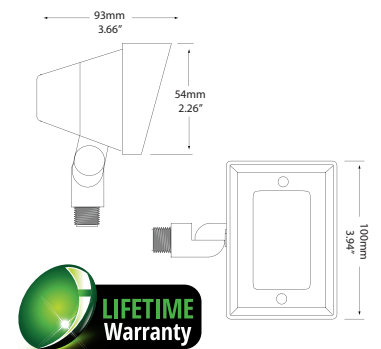



Create dramatic washing, silhouetting, and shadowing effects with our diminutive Heidi, alongside Wally for larger vertical surfaces. Compact Rowan fixtures are perfect for downlighting to complete the effect.

SOLID BRASS OUTDOOR Fixtures

SANDY | WELL LIGHT

Designed to be buried in-ground to direct light upwards while remaining discreet, Sandy can be installed flush within a landscape or hardscape surface and is especially effective for accenting trees and tall grasses.



Recommended Lamp	LED MR16
Weight	2.50 lbs
Socket	Pre-greased Beryllium Copper
Wattage	Maximum 20W
Voltage	12V
Lens	Clear Convex Tempered Glass
Lens Cover	Grate or Ring
Includes	36" 18/2 UL-Rated Wire, PVC Installation Sleeve
Accessory	Eyebrow (sold separately)

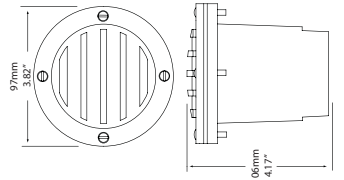

CLAY | IN-GROUND LIGHT

Designed with a weather aged brass trim ring and flush tempered glass lens. Structured with a 316 marine grade stainless steel composite body for enhanced stability in loose soil or frost cycles. This fixture is ideal for grazing trees or walls.



Recommended Lamp	LED MR16
Weight	1.87 lbs
Socket	GU5.3
Wattage	Maximum 20W
Voltage	9-15V AC/DC
Lens	Clear Lens
Includes	5' SJTW 2 x 18AWG Cable

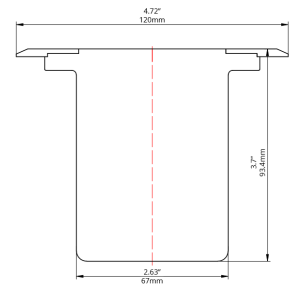

CLAIRE | PENDANT LIGHT

This hanging 12V twinkler light is the perfect addition to pergolas, seating areas, and outdoor kitchen & dining areas, designed to provide stylish task and ambient lighting. Fixture is adjustable to 2 different heights depending on desired look and application.



Recommended Lamp	MR11
Weight	1.3 lbs
Socket	Pre-greased Beryllium Copper
Wattage	Maximum 20W
Voltage	12V
Includes	24" 18/2 UL-Rated Wire

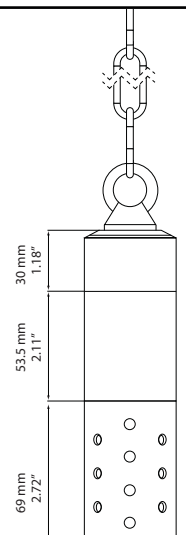

ROXY | PATH & AREA LIGHT



With an adjustable lamp base for versatile light spread, Roxy casts soft, symmetrical light patterns on the ground, ideal for areas around landscape features such as plants beds, ponds, or flowering plants.

Recommended Lamp	LED G4 Bipin
Weight	2.35 lbs
Socket	Pre-greased Beryllium Copper
Wattage	Maximum 20W
Voltage	12V
Lens	Clear Tempered Glass
Includes	7" Brass Stake, 36" 18/2 UL-Rated Wire

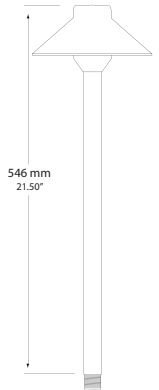
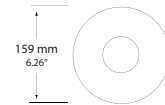

Roxy's soft, mellow light is ideal for illuminating walkways, beds, borders, and stairs, as well as accenting landscape features.

SOLID BRASS OUTDOOR **Fixtures**

HERB | EXTENDABLE PATH & AREA LIGHT



A wide area light ideal for accenting walkways, plant beds, and borders. The extendable stem easily adjusts from 20" to 32" to complement growing plant materials.

Recommended Lamp	LED G4 Bipin
Weight	2.35 lbs
Socket	Pre-greased Beryllium Copper
Wattage	Maximum 20W
Voltage	12V
Lens	Clear Tempered Glass
Includes	7" Brass Stake, 36" 18/2 UL-Rated Wire

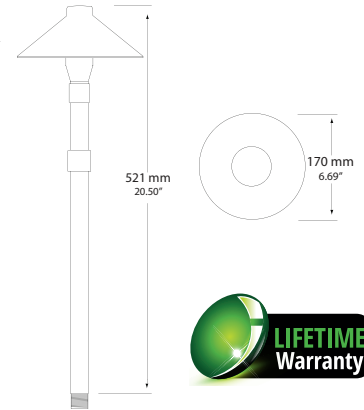

MISTY | PATH & AREA LIGHT



A smaller scale light with a narrow, compact beam spread, perfect for focused highlights. Misty is ideal for edging driveways and small garden paths.

Recommended Lamp	LED G4 Bipin
Weight	2.35 lbs
Socket	Pre-greased Beryllium Copper
Wattage	Maximum 20W
Voltage	12V
Lens	Clear Tempered Glass
Includes	7" Brass Stake, 36" 18/2 UL-Rated Wire

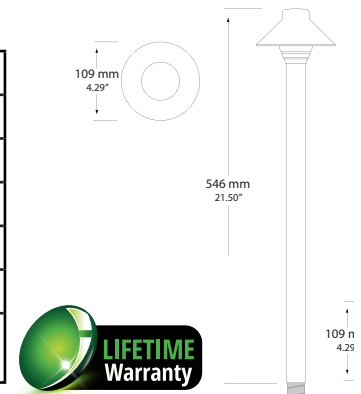

ASPEN | EXTENDABLE PATH & AREA LIGHT



A wide-brimmed area light that produces low-level light. Ideal for low-level lighting along walkways and entryways. The extendable stem adjusts from 20" to 32".

Recommended Lamp	LED G4 Bipin
Weight	2.35 lbs
Socket	Pre-greased Beryllium Copper
Wattage	Maximum 20W
Voltage	12V
Lens	Clear Tempered Glass
Includes	7" Brass Stake, 36" 18/2 UL-Rated Wire

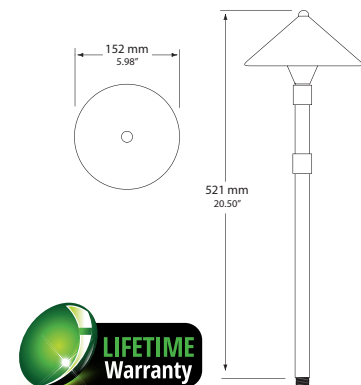

BENTLEY | PATH & AREA LIGHT



An elegant shepherd's hook path light featuring a directional hood, producing a low impact, shielded light. Ideal for casting textured shadows onto pathways.

Recommended Lamp	LED G4 Bipin
Weight	2.35 lbs
Socket	Pre-greased Beryllium Copper
Wattage	Maximum 20W
Voltage	12V
Lens	Clear Tempered Glass
Includes	7" Brass Stake, 36" 18/2 UL-Rated Wire

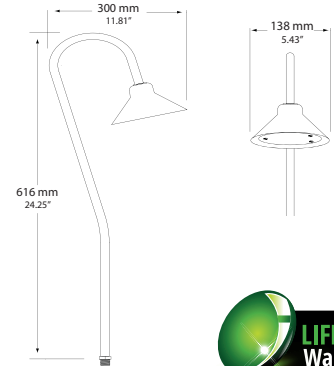

PEARL | PATH & AREA LIGHT



A contemporary dome cap that produces a soft, warm glow. Ideal for decorative accents, pathways, walkways, and flower beds.

Recommended Lamp	LED G4 Bipin
Weight	3.45 lbs
Socket	Pre-greased Beryllium Copper
Wattage	Maximum 20W
Voltage	12V
Lens	Clear Tempered Glass
Includes	7" Brass Stake, 36" 18/2 UL-Rated Wire

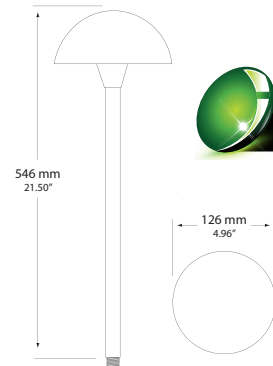

SOLID BRASS OUTDOOR **Fixtures**



Create a soft, warm glow with Declan Deck & Niche Lights, the perfect addition to your deck, fence, pergola or seating area. This dual-purpose light fixture can be flipped vertically for use as a sconce.

DECLAN | DECK & NICHE LIGHT

A dual-purpose light fixture with an adjustable socket for varying light output. Declan can be used as a post light or a sconce when flipped vertically. Ideal for deck, pergolas, and outdoor sitting areas.



Recommended Lamp	LED T5 Wedge
Weight	1.45 lbs
Socket	Pre-greased Beryllium Copper
Wattage	Maximum 20W
Voltage	12V
Lens	Clear Tempered, Linear Glass
Includes	96" 18/2 UL-Rated Wire, Mounting Template

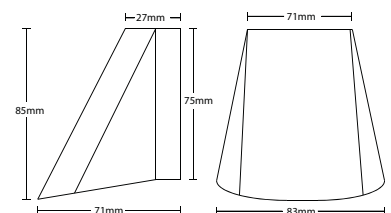

SIERRA | DECK & NICHE LIGHT



A diminutive niche luminaire designed for mounting on posts, decks, or where a smaller beamspread is required - the perfect size for pool enclosures! The small fixture includes 8 feet of wire and a key hole slot in the back for easy installation.

Recommended Lamp	LED 19 mm T5 Wedge
Weight	1 lb
Socket	Pre-greased Beryllium Copper
Wattage	Maximum 20W
Voltage	12V
Includes	8' 18/2 UL-Rated Wire

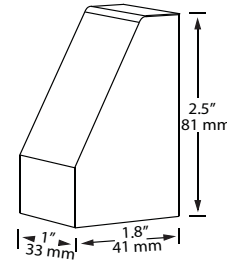

GINGER | DECK & NICHE LIGHT



With a louvered brass lens cover, this deck light provides soft, glare-free ambient lighting. Ginger creates a casual, comfortable atmosphere for relaxing or entertaining.

Recommended Lamp	LED G4 Bipin
Weight	1.45 lbs
Socket	Pre-greased Beryllium Copper
Wattage	Maximum 10W
Voltage	12V
Installed Lens	Clear Tempered, Linear Glass
Includes	36" 18/2 UL-Rated Wire, Frosted & Flat Lenses

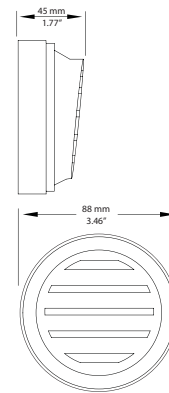

OPAL | DECK & NICHE LIGHT



A half-moon, modern style for subtle, soft lighting. Opal can be tucked into small nooks and edges for discreet lighting.

Recommended Lamp	LED G4 Bipin
Weight	1.45 lbs
Socket	Pre-greased Beryllium Copper
Wattage	Maximum 10W
Voltage	12V
Installed Lens	Clear Tempered, Linear Glass
Includes	36" 18/2 UL-Rated Wire, Frosted & Flat Lenses

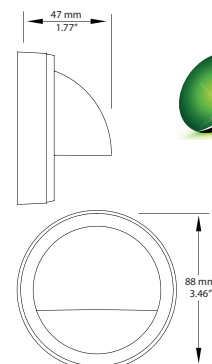

SOLID BRASS OUTDOOR Fixtures

BROOK | SUBMERSIBLE LIGHT



Designed for installation in ponds and water gardens, Brook has a water-tight housing gasket and wire seal. The fully-rotatable shroud is perfect for underwater lighting, highlighting marine life, and creating moving shadows in and out of the water.

Recommended Lamp	LED MR16
Weight	3.00 lbs
Socket	Pre-greased Beryllium Copper
Wattage	Maximum 20W
Voltage	12V
Lens	Clear Tempered Glass
Includes	12' 18/2 UL-Rated Wire

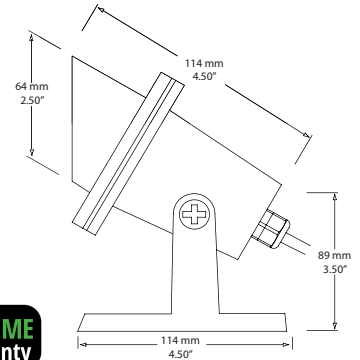

CLIFF | INTEGRATED LED COPING LUMINAIRE

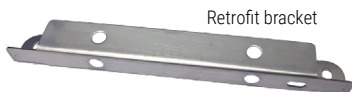

Retrofit bracket



Cliff Mount



A 6" solid brass coping light with 6 integrated LEDs, perfect for hardscapes and step lighting. Cliff can be mounted horizontally between surfaces using the flat stainless steel mounting bracket.

Rating	IP65
Lumen Output	206 Lumens
Color Temperature	2700K, 3000K
Weight	0.66 lbs
Wattage	2.5 W
Voltage	12~15VAC/DC
Lens	1/8" Flat Tempered Glass
Includes	96" 18/2 UL-Rated Wire, Flat Stainless Steel Bracket Mount
Accessories	6" Retrofit bracket & 6" adjustable Cliff Mount (each sold separately)

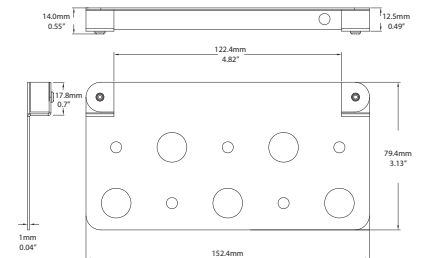

Dimmable

CLIFF MINI | INTEGRATED LED COPING LUMINAIRE

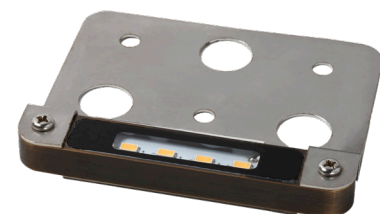

The 3.5" version of Cliff, our solid brass coping light, with 4 integrated LEDs. This luminaire is ideal for smaller hardscape features or more discreet applications.

Rating	IP65
Lumen Output	105 Lumens
Color Temperature	2700K, 3000K
Weight	0.48 lbs
Wattage	1.5 W
Voltage	12~15VAC/DC
Lens	1/8" Flat Tempered Glass
Includes	96" 18/2 UL-Rated Wire, Flat Stainless Steel Bracket Mount

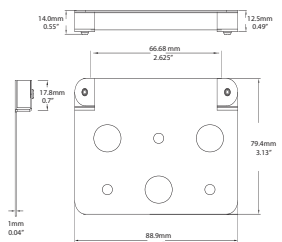

Dimmable



(TOP) Cliff Integrated LED coping lights pictured are recessed into timbers to light the screens and seating below. Cliff provides wide, soft, glare-free ambient lighting perfect for illuminating hardscape structures.

(RIGHT) With a fully rotatable shroud, the Brook submersible fixture is an ideal choice for underwater uplighting in ponds, water gardens and waterfall features.



PRECISION ENGINEERED **Luminaires**

Engineered with premium materials and paired with a modern, contemporary design, these luminaires are perfect for architectural applications. The Precision Engineered line offers a complete solution for exterior lighting applications.

Each precision engineered ground mount fixture includes a 7-9" brass or stainless steel stake.



Marine Grade Stainless Steel

Stainless steel provides the perfect blend of stylish, sleek design and a semi-industrial look, making it the perfect accent for contemporary designs. Due to the high durability metal's corrosion and deterioration resistance, it does not discolor, rust, or fade away.



Machined 8 mm Copper

Our 8 mm copper luminaires offer old-world sophistication and age gracefully over time to produce a natural verdigris patina when exposed to the outdoor elements. Copper has inherent stain-resistant qualities, is simple to maintain, and does not corrode or rust over time.

ADONIS & ADONIS SS | EXTENDABLE PATH & AREA LIGHT



A classic two-tiered pagoda light with an adjustable brass bushing for widening light output and a telescopic stem that extends from 19" to 33". Adonis is effective as a path or accent light.

Construction	Heavy Gauge Copper/ Marine Grade Stainless Steel
Recommended Lamp	LED G4 Bipin
Weight	3.00 lbs
Socket	Ceramic MR16 Socket
Wattage	Maximum 20W
Voltage	12V
Installed Lens	1/8" Tempered Glass
Includes	6' 18/2 UL-Rated Wire, 9" Brass Stake

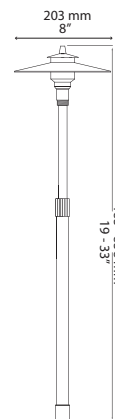

APHRODITE & APHRODITE SS | EXTENDABLE PATH & AREA LIGHT

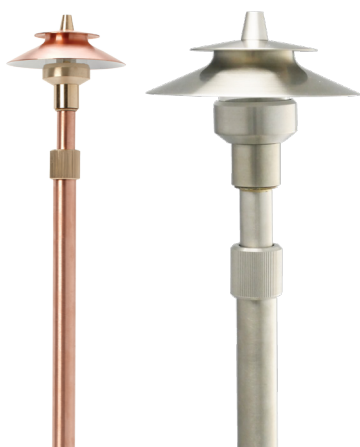

A smaller two-tiered pagoda light with an adjustable brass bushing and an extendable stem that adjusts from 19" to 33". Ideal for accent lighting for plant material in low plant beds or path lighting.

Construction	Heavy Gauge Copper/ Marine Grade Stainless Steel
Recommended Lamp	LED G4 Bipin
Weight	3.00 lbs
Socket	Ceramic MR16 Socket
Wattage	Maximum 20W
Voltage	12V
Installed Lens	1/8" Tempered Glass
Includes	6' 18/2 UL-Rated Wire, 9" Brass Stake

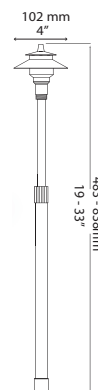

ORION | IN-GROUND LIGHT

Designed for in-ground installation in lawns, stone, wood, or masonry. Orion is durable enough to be stepped on or run over by light vehicles. This luminaire can be installed with or without the included PVC sleeve.



Construction	Marine Grade Stainless Steel
Recommended Lamp	LED MR16
Weight	2.35 lbs
Socket	Ceramic MR16 Socket
Wattage	Maximum 10W
Voltage	12V
Installed Lens	1/8" Tempered Glass
Includes	36" 18/2 UL-Rated Wire, PVC Installation Sleeve

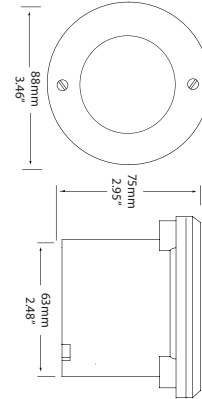

DEMETER | IN-GROUND LIGHT

An in-ground luminaire with an 88 mm low-profile flange, a recessed body, and a louvered cover. This luminaire is suitable for in-ground turf installations or recessed in wood or masonry projects. This luminaire can be installed with or without the included PVC sleeve.



Construction	Marine Grade Stainless Steel
Recommended Lamp	LED MR16
Weight	2.35 lbs
Socket	Ceramic MR16 Socket
Wattage	Maximum 10W
Voltage	12V
Installed Lens	1/8" Tempered Glass
Includes	36" 18/2 UL-Rated Wire, PVC Installation Sleeve

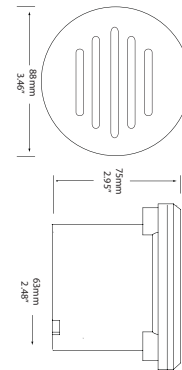

EROS & EROS SS | DIRECTIONAL LIGHT

A compact, sleek luminaire with the flexibility of ground and surface mount all in one box. Use the bracket for downlighting applications, or ground stake for uplighting.



Construction	Machined Copper (Eros) 316 Marine Grade Stainless Steel (Eros SS)
Recommended Lamp	LED MR11
Weight	1 lb
Socket	Ceramic MR11 Socket
Wattage	Maximum 20W
Voltage	12V
Installed Lens	1/8" Flat Tempered Glass
Includes	7" Copper plated SS Stake, Removable Shroud, 8' 18/2 UL-Rated Wire

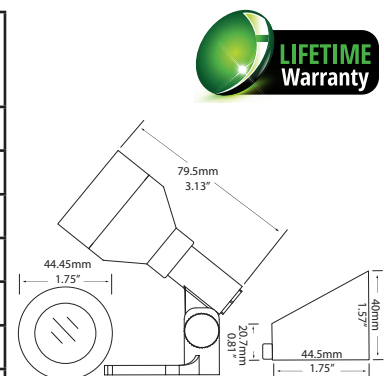

PRECISION ENGINEERED **Luminaires**

LETO | DIRECTIONAL LIGHT



A compact, sleek spot luminaire ideal for uplighting. Highly durable with a modern look, Leto offers superior strength and reliability.

Construction	316 Marine Grade Stainless Steel
Recommended Lamp	LED MR16
Weight	2.35 lbs
Socket	Ceramic MR16 Socket
Wattage	Maximum 20W
Voltage	12V
Installed Lens	1/8" Tempered Convex Glass
Includes	36" 18/2 UL-Rated Wire, 7" Stainless Steel Stake

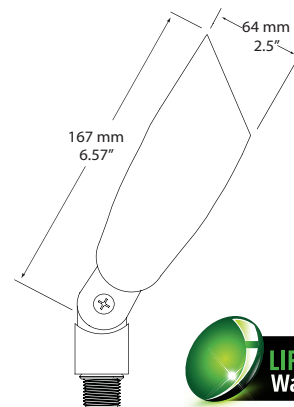

ALDER | DIRECTIONAL LIGHT



Named after the native North American birch tree, Alder, Illumicare's copper uplight, is truly "King of the Woods". The fully rotatable shroud is fitted with a silicone o-ring gasket to ensure a weather-tight seal in harsh weather conditions.

Construction	Machined Copper
Recommended Lamp	LED MR16
Weight	2.35 lbs
Socket	Beryllium Copper MR16 Socket
Wattage	Maximum 20W
Voltage	12V
Installed Lens	1/8" Tempered Convex Glass
Includes	36" 18/2 UL-Rated Wire, 7" Brass Stake

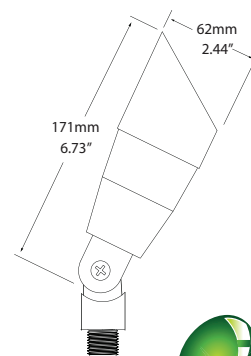

ARTEMIS SS & ARTEMIS COPPER | DIRECTIONAL LIGHT



An adjustable wall mount with an angled shroud for glare control. Available in stainless steel and copper, the fixture is ideal for highlighting accent pieces.

Construction	316 Marine Grade Stainless Steel (Artemis SS) Machined 8 mm Copper (Artemis Copper)
Recommended Lamp	LED MR16
Weight	3.00 lbs
Socket	Ceramic MR16 Socket
Wattage	Maximum 20W
Voltage	12V
Installed Lens	1/8" Flat Tempered Glass
Includes	36" 18/2 UL-Rated Wire, Fully Adjustable Bracket

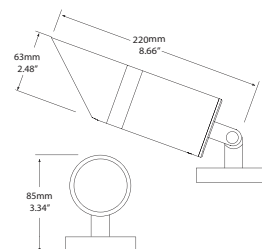

EREBUS SS & EREBUS COPPER | DIRECTIONAL LIGHT



An elegant wall mount with bidirectional light output available in both stainless steel and copper construction. Mount on vertical surfaces for simultaneous up and down lighting.

Construction	316 Marine Grade Stainless Steel (Erebus SS) Machined 8 mm Copper (Erebus Copper)
Recommended Lamp	LED MR16
Weight	3.00 lbs
Sockets	Two Ceramic MR16 Sockets
Wattage	Maximum 20W
Voltage	12V
Installed Lens	1/8" Flat Tempered Glass
Includes	36" 18/2 UL-Rated Wire

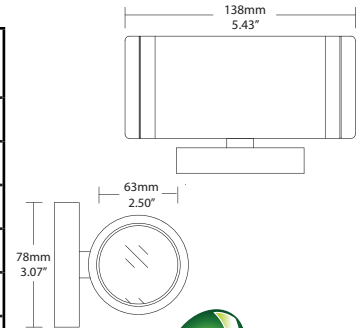

Leto accentuates the foliage and tree structure, while Aphrodite marks grade changes and highlights plant material amidst soft moonlighting.

PRECISION ENGINEERED **Luminaires**

NYX & NYX SS | DECK & NICHE LIGHT



A diminutive niche luminaire designed for mounting on posts, decks, or where a smaller beamspread is required - the perfect size for pool enclosures! The small fixture includes 8 feet of wire and a key hole slot in the back for easy installation.

Construction	Heavy Gauge Copper (Nyx) 316 Marine Grade Stainless Steel (Nyx SS)
Recommended Lamp	LED 19 mm T5 Wedge
Weight	0.4 lbs
Socket	T5 Wedge Socket
Wattage	Maximum 20W
Voltage	12V
Includes	8' 18/2 UL-Rated Wire

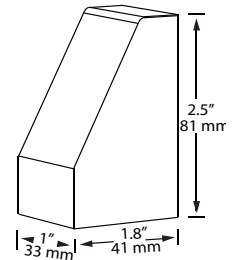

SELENE | DECK & NICHE LIGHT



A versatile, cone-shaped light fixture, used for deck or post lighting. The simple yet elegant styling adds a unique element to any outdoor setting.

Construction	Machined 8 mm Copper
Recommended Lamp	LED 19 mm T5 Wedge
Weight	0.2 lbs
Socket	T5 Wedge Socket
Wattage	Maximum 20W
Voltage	12V
Includes	8' 18/2 UL-Rated Wire

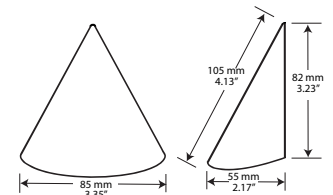

HELIOS | DECK & NICHE LIGHT



A compact, wall mount step light in a contemporary design. The shield masks two thirds of the light output, eliminating glare and providing soft, ambient lighting. Helios is designed for vertical mounting on masonry, stone, or wood surfaces.

Construction	Marine Grade Stainless Steel
Recommended Lamp	LED G4 Bipin
Weight	2.35 lbs
Socket	Ceramic G4 Bipin Socket
Wattage	Maximum 10W
Voltage	12V
Installed Lens	1/8" Tempered Frosted Glass
Includes	36' 18/2 UL-Rated Wire

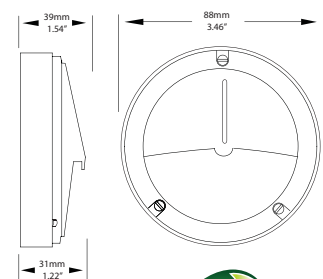

ASTERIA SS & ASTERIA COPPER | DIRECTIONAL LIGHT



A sleek wall mount with a fixed directional light output available in both stainless steel and copper. Ideal for columns and accenting architectural features.

Construction	316 Marine Grade Stainless Steel (Asteria SS) Machined 8 mm Copper (Asteria Copper)
Recommended Lamp	LED MR16
Weight	2.35 lbs
Socket	Ceramic MR16 Socket
Wattage	Maximum 20W
Voltage	12V
Installed Lens	1/8" Flat Tempered Glass
Includes	36" 18/2 UL-Rated Wire

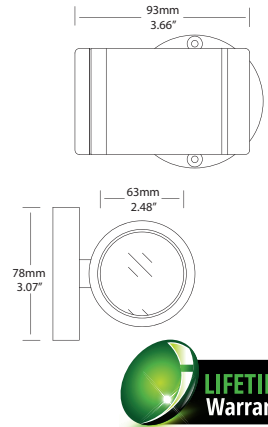

Precision Engineered Asteria mounts compliment most architectural finishes and masonry, seen here blending into the pergola structure, while adding elegance and remaining unobtrusive.



PRECISION ENGINEERED Luminaires

PROTEUS SS & PROTEUS BRASS | SURFACE MOUNT DOCK LIGHT



Dimmable

Offered in 316 marine grade stainless steel or solid brass, this compact dock light with integrated LEDs provides 360 degrees of warm white light. Included small wire hole for minimally invasive installation.

Construction	Solid Brass 316 Marine Grade Stainless Steel
LED Chip	CREE COB
Lumen Output	85 Lumens
Color Temperature	3000K
Wattage	Maximum 0.9W
Voltage	9-15V AC/DC
Rating	IP65
Includes	SJOW/ 5ft 18AWG Rubber Cable

10 YEAR Warranty

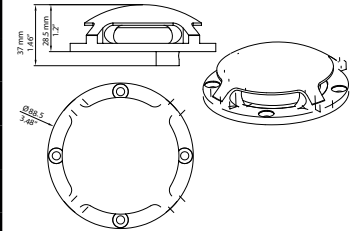

PHOEBE SS & PHOEBE COPPER | INTEGRATED LED COPING LUMINAIRE

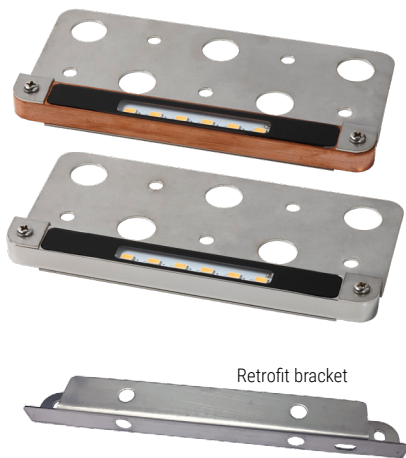

Retrofit bracket

Dimmable

A 6" coping light with 6 integrated LEDs, available in stainless steel and copper. Perfect for hardscapes and step lighting. The fixture can be mounted horizontally between surfaces using the flat stainless steel mounting bracket.

Construction	316 Marine Grade Stainless Steel (Phoebe SS) Machined 8 mm Copper (Phoebe Copper)
Rating	IP65
Lumen Output	206 Lumens
Color Temperature	3000K
Weight	0.66 lbs
Wattage	2.5 W
Voltage	12~15V AC/DC
Lens	1/8" Flat Tempered Glass
Includes	96" 18/2 UL-Rated Wire, Flat Stainless Steel Bracket Mount
Accessory	6" Retrofit bracket (sold separately)

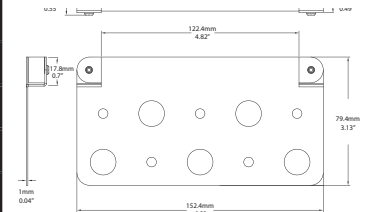

10 YEAR Warranty

PHOEBE SS MINI & PHOEBE COPPER MINI | INTEGRATED LED COPING LUMINAIRE



Dimmable

The 3.5" version of Phoebe with 4 integrated LEDs, ideal for smaller hardscape features and for more discreet applications.

Construction	316 Marine Grade Stainless Steel (Phoebe SS) Machined 8 mm Copper (Phoebe Copper)
Rating	IP65
Lumen Output	105 Lumens
Color Temperature	3000K
Weight	0.48 lbs
Wattage	1.5 W
Voltage	12~15VAC/DC
Lens	1/8" Flat Tempered Glass
Includes	96" 18/2 UL-Rated Wire, Flat Stainless Steel Bracket Mount

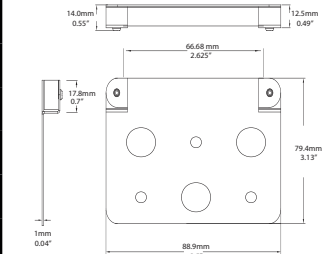

10 YEAR Warranty



The compact Proteus surface mount dock light provides 360 degrees of warm white light, perfect for applications around including docks and pool decks. A perfect combination of safety and incandescence.

IN-GROUND Luminaires

Perfect for Illuminating Large Trees

Properly lighting large specimen trees can be challenging, but visually powerful when done correctly! Designed to be buried in-ground to direct light upwards while remaining discreet, our new line of integrated LED, in-ground luminaires can be installed flush within a landscape or hardscape surface and especially effective for accenting large trees. Available in three sizes, these luminaires are constructed of stainless steel with an aluminum body, and a removable ABS sleeve for easy installation.

EVIE | IN-GROUND LIGHT



Directional, Round, In-Ground, Stainless Steel	
Lumen Output	359 Lumens
Color Temperature	3000K
Wattage	6 W
Lens	Asymmetrical
Voltage	12V
IP Rating	IP67
Includes	12" UL Listed 18/2 Lead Wire, ABS Pour Sleeve

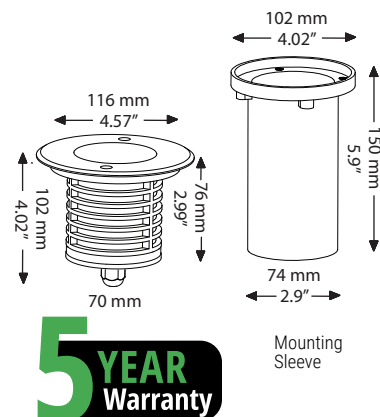

ASTRID | IN-GROUND LIGHT



Directional, Round, In-Ground, Stainless Steel	
Lumen Output	709 Lumens
Color Temperature	3000K
Wattage	12 W
Lens	Asymmetrical
Voltage	12V
IP Rating	IP67
Includes	12" UL Listed 18/2 Lead Wire, ABS Pour Sleeve

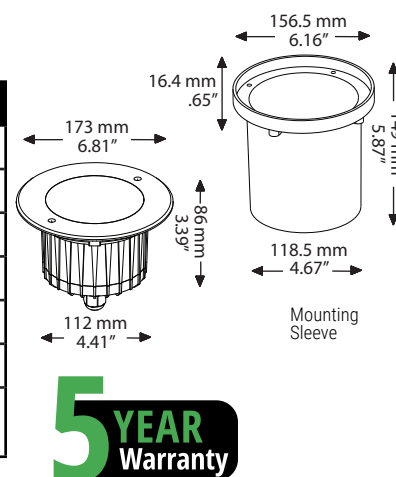

NOVA | IN-GROUND LIGHT



Directional, Round, In-Ground, Stainless Steel	
Lumen Output	1605 Lumens
Color Temperature	3000K
Wattage	18 W
Lens	Asymmetrical
Voltage	12V
IP Rating	IP67
Includes	12" UL Listed 18/2 Lead Wire, ABS Pour Sleeve

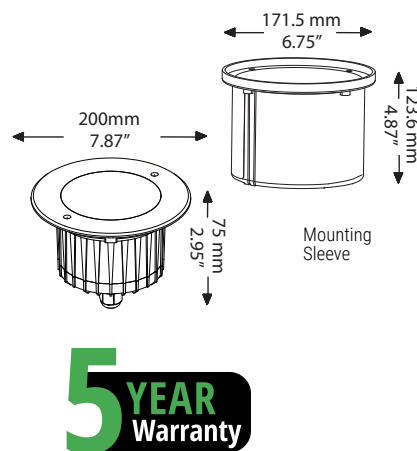



Especially effective for accenting large features, Evie in-ground luminaires create visually powerful art, bringing objects to life while remaining discreetly buried.

SYMPHONY HARDSCAPE **Luminaires**

Add Harmony to your Outdoor Living Space

Symphony Hardscape In-Grade Luminaires' innovative modular design brings even more versatility and flexibility to hardscape lighting. Ideal for marking edges or pathways and designed for brick, stone, paver, and concrete applications, Symphony's superior light output illuminates vertical surfaces including as pillars, borders, steps, fences and more. Illumicare's Symphony luminaires are perfect for your next hardscape project.

NEW MODULAR DESIGN

Symphony Hardscape In-Grade Luminaire Features:

- 5 interchangeable tops styles.
- Each style available in stainless steel or antique brass finish.
- Field serviceable.
- Durable brass body.
- Available in 2700K and 3000K.
- Removable LED module.
- Removable ABS Installation Sleeve.
- Mozart and Chopin luminaires offer both a unique 45° asymmetrical angled optic to reduce glare, as well as a 35° standard beam spread.

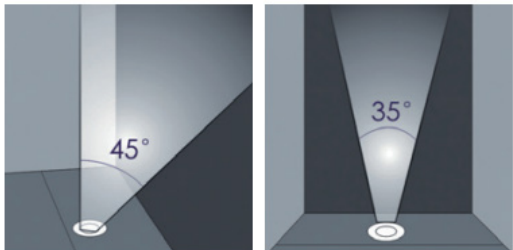

Mix & match to compose the perfect fixture for every application.

Choose from 5 different styles of tops, available in either stainless steel or antique brass, paired with an antique brass body and removable LED module offered in 2 colour temperatures with two different optic choices.

Antique Brass Body	+	LED Module	+	Tops available in Stainless Steel or Antique Brass
<p>Brass body includes an ABS pour sleeve</p>		<p>Interchangeable optics ~ asymmetrical or spread lens. Available in 2700k & 3000K</p>		<p>MOZART CHOPIN BRAHMS 1 BRAHMS 2 BRAHMS 4</p>

Select the top of your choice to complete your desired finish.



The new Symphony modular design provides excellent, flexible performance in both uplighting and downlighting - including pillars, borders, low walls, steps, sunken seating areas, and fences.

SYMPHONY HARDSCAPE Luminaires

A Finish for Every Application

Available in different colour temperatures, our in-grade luminaires are constructed of stainless steel or antique brass, with a removable LED module.

5 YEAR
Warranty

Specifications:	LED MODULE	BRASS BODY	MOZART	CHOPIN	BRAHMS 1	BRAHMS 2	BRAHMS 4
Dimensions	1-15/16" Dia x 1-1/2" H	1-9/16" Dia x 2-7/8" H	2-3/16" Dia x 1/2" H	2-3/16" SQ x 1/2" H	2-3/16" Dia x 13/16" H	2-3/16" Dia x 13/16" H	2-3/16" Dia x 13/16" H
Lumens	155 Lumens	N/A	N/A	N/A	N/A	N/A	N/A
Color Temperature	2700K & 3000K	N/A	N/A	N/A	N/A	N/A	N/A
Voltage	9-15V AC/DC	N/A	N/A	N/A	N/A	N/A	N/A
Wattage	2.5W	N/A	N/A	N/A	N/A	N/A	N/A
Construction	Stainless Steel	Antique Brass	Stainless steel/ Antique Brass	Stainless steel/ Antique Brass	Stainless steel/ Antique Brass	Stainless steel/ Antique Brass	Stainless steel/ Antique Brass
IP Rating	IP67	IP67	N/A	N/A	N/A	N/A	N/A
Includes	Asymmetrical Lens and Spread Lens	12" UL Listed 18/2 Lead Wire, ABS Pour Sleeve	Frosted & Clear Lens	Frosted & Clear Lens	Frosted Lens	Frosted Lens	Frosted Lens

Note: Drive-over Rated to 4400lbs

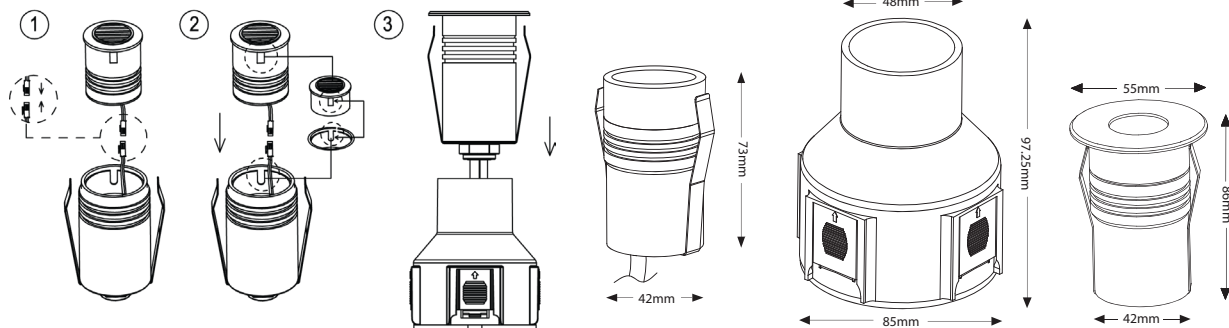

[CLICK FOR SPEC SHEET](#)

HAYDN | IN-WALL



45° Output, Round, Recessed, Stainless Steel	
Lumen Output	40 Lumens
Wattage	1.3 W
Lens	Flat 1/2" Flat Tempered Glass
Weight	0.5 lb
Voltage	12V
IP Rating	IP65
Includes	12" UL Listed 18/2 Lead Wire, ABS Sleeve w/Anchor Bolts

2 YEAR Warranty

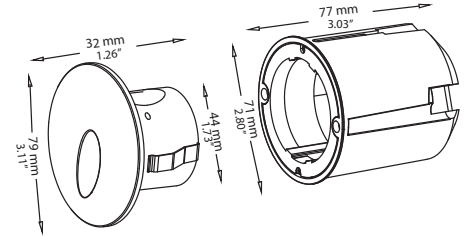

VIVALDI | IN-WALL



45° Output, Round, Recessed, Stainless Steel	
Lumen Output	40 Lumens
Wattage	1.3 W
Lens	Flat 1/2" Flat Tempered Glass
Weight	0.5 lb
Voltage	12V
IP Rating	IP65
Includes	12" UL Listed 18/2 Lead Wire, ABS Sleeve w/Anchor Bolts

2 YEAR Warranty

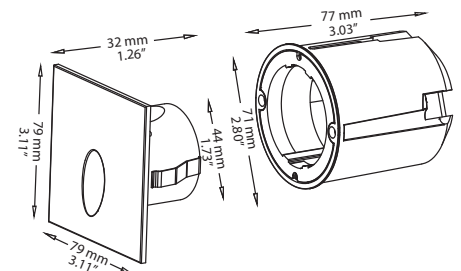

INSTALLATION TOOLS

Tools may be purchased separately for easy installation of Illumicare's Symphony Hardscape Luminaires.

Our 1 3/4" coring bit, 5/8" x 11" drive and a 1/2 shank are sized perfectly for the luminaires.



CONTRAST Fixtures

Minimalist Design for Bold Presentation

Illumicare's Contrast Fixtures create a distinctive look using rich, powder-coated black and white finishes. Made of premium materials, these fixtures will stand up to outdoor elements. These luminaires can be used for discreet applications or for adding striking accents to intensify lighting designs.

THE SHADOW | ALUMINUM DIRECTIONAL LIGHT



The Shadow is constructed of aircraft-grade aluminum (A360.0) for superior strength and reliability. Sealed through an anodization process with an embedded electrophoresis coating, the metal is smooth, anti-corrosive, and scratch-resistant. This combination of inner and outer coatings creates a durable, long-lasting finish.

The Shadow is the only professional grade fixture with this exclusive dual-coating, not a painted finish that will peel or fade.

Construction	Anodized Aluminum
Finish	Black Anti-Corrosion Coating
Shroud	Quick Lock with Set Screw
Socket	Pre-greased Beryllium Copper, MR16 Socket
Recommended Lamp	LED MR16
Wattage	Maximum 20W
Voltage	12V
Lens	Clear Convex Tempered Glass
Weight	1.75 lbs
Includes	Plastic Stake, 36" 18/2 UL Rated Lead Wire

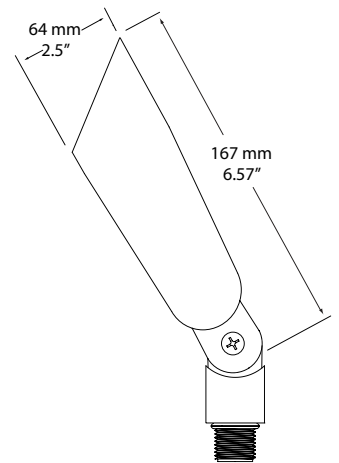

SILHOUETTE & PROFILE | POWDER-COATED DECK & NICHE LIGHT



Silhouette and Profile are constructed of highly durable cast stainless steel and finished with a protective powder-coating. These diminutive niche luminaires are designed for mounting on posts, or decks.

Construction	Cast Stainless Steel
Finish	Black Powder Coating (Silhouette) White Powder Coating (Profile)
Recommended Lamp	LED 19 mm T5 Wedge
Weight	0.4 lbs
Socket	Ceramic T5 Wedge Socket
Wattage	Maximum 20W
Voltage	12V
Includes	8' 18/2 UL-Rated Wire

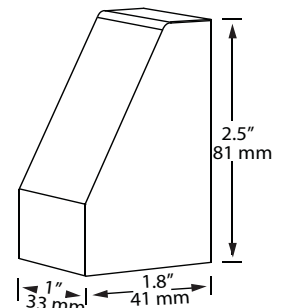









CREATE A STRIKING EFFECT WITH OUR CONTRAST FIXTURES

To ensure the highest durability possible, all CONTRAST FIXTURES are sealed with a hard anodized process, and an electrophoresis coating is embedded into the metal to produce a smooth anti-corrosion, scratch-resistant finish. The slim design of the Silhouette and Profile fixtures is a great fit for fences, pool, and hot tub enclosures.

SMART Home with ILLUMISMART

Automation at your Fingertips

Take control of your outdoor living spaces! Whether you're designing a new outdoor space or retrofitting an existing one, the Merlin Zone Control System, paired with the new Merlin Hub and WiFi Smart Sockets creates a versatile and easy-to-install wireless system.

-  Smart Home products work with a 2.4GHz WiFi network.
-  Easy to use App control - just download, plug in and connect your devices.
-  Set automatic daily timers and create on/off schedules for each device.
-  Control receptacles individually or group devices for unified control with a single tap.
-  Save energy and money - never forget to turn off lighting or appliances again!
-  Control your home and yard by voice command by pairing your Illumicare smart home products with Amazon Alexa or Google Assistant.



Download the free Illumismart App for easy-to-use zone creation, scheduling and control.
ANYWHERE. ANYTIME.

Connect your devices and start managing your lighting and home electronics today - it's that easy!

MERLIN ZONE CONTROL



- WiFi / cloud-based programming
- Independently program up to 8 zones on single or multiple transformers
- Receivers can be installed anywhere on the secondary 12V side
- Control each zone with separate receivers or use multiple receivers/zone
- Astronomical controls and automatic geo-locators
- Communication ranges of up to 1000 ft (300m) (RF only)
- Radio frequency for manual control
- Simple on/off wireless transmitter overrides scheduled events instantly without adjusting the entire program

Dimensions	RX - 25.6" x 3.9" x 1.4" TX - 5.3" x 1.8" x 0.75"
Voltage	Merlin RX - AC / DC 12V 25A Max
Construction	Polycarbonate
Cable Length	17.7"
WiFi Standard	2.4GHz b/g/n
Communication Range	1000 feet (300m) (RF only)
Working Temp	-40° - 60°C

2 YEAR
Warranty

MERLIN HUB



Hybrid WiFi/ RF Control

This hybrid hub offers the convenience of WiFi programming with the long range of RF. Including up to 1000ft line of sight for 6 zones-multiple devices per zone, the Merlin Hub connects anywhere indoor with strong WiFi and does not need ethernet connection to router.

Construction	Engineering Plastic
Hub Dimensions	4.7" x 4.7" x 1"
Antenna Length	7.7"
Input	100-240V - 50/60Hz
WiFi Standard	802.11 b/g/n, 2.4GHz



SMART Home

WIFI SMART SOCKET



Remotely control and schedule your lighting and other home electronics from any location, right from your smart phone or tablet. The WiFi Smart Socket works with any standard outlet and is compact enough to easily fit inside most low voltage lighting transformers.

Dimensions	1.8" w x 1.8" l x 1.8" h
Power Supply	AC 100V-125V / 50/60 Hz
Load Current	10A Max, Resistive
WiFi Standard	2.4GHz b/g/n
Working Temp	-20° - 50°C

2 YEAR
Warranty

OUTDOOR WIFI SMART SOCKET



This multi-outlet, weather resistant Outdoor WiFi Smart Socket allows individual control of up to three outdoor devices with one socket. With an IP44 water resistant housing, it's designed to work with your low voltage lighting transformer, providing remote control for lighting and other outdoor systems right from your smart phone, wherever you are. Ideal for use on decks, patios and in gardens.

Dimensions	4" w x 5.2" l x 1.5" h
Rating	AC 110V-240V / 10A (per switch) 1200W
Waterproof Standard	IP44
WiFi Standard	2.4GHz b/g/n
Cable Length	4.5"
Working Temp	-10° - 45°C

2 YEAR
Warranty



TRANSFORMERS

MIC, MILLIE, MINNIE & DEMI | MULTI-TAP, TOROIDAL 12V TRANSFORMERS

MIC 75W Transformer w/built-in timer



For demanding landscape lighting projects that require power and flexibility to accommodate multiple wire runs, Illumicare's low voltage transformers are the perfect fit.

Whether you need a short wire run to light a few clustered fixtures, or a longer wire run to power enough fixtures to illuminate a 200 foot driveway, our transformers offer voltage taps ranging from 12 to 15 volts. Illumicare's multiple voltage taps reduce the risk of installing wire runs that lower the light output, change the color temperature, shorten the lamp life, or even burn lamps too hot.

Features:

- Toroidal Core Transformer
- Extra Large Terminal Strips
- Magnetic Circuit Breakers
- Stainless Steel Enclosures
- Removable, Lockable Latched Door
- Timer & Photocell Outlets
- Built-in Timer (75W)



	75W	150W	300W	600W
LED MR16	15 Lamps	30 Lamps	60 Lamps	120 Lamps
LED MINIATURE	20 Lamps	40 Lamps	90 Lamps	150 Lamps

	MIC	MILLIE	MINNIE	DEMI
Part Number	TR75-1215	TR150-1215	TR300-1215	TR600-1215
Input	120V~60Hz 0.65A Max	120V~60Hz 1.4A Max	120V~60Hz 2.5A Max	120V~60Hz 5A Max
Output	75W-12V~/13V~/14V~/15V~	150W-12V~/13V~/14V~/15V~	300W-12V~/13V~/14V~/15V~	600W-12V~/13V~/14V~/15V~
Construction	Stainless Steel	Stainless Steel	Stainless Steel	Stainless Steel
Weight	7 lbs	15 lbs	22 lbs	28 lbs
Dimensions	165 mm x 114 mm x 114 mm 6.5" x 4.5" x 4.5"	420 mm x 167 mm x 153 mm 16.54" x 6.57" x 6.02"	420 mm x 167 mm x 153 mm 16.54" x 6.57" x 6.02"	420 mm x 167 mm x 153 mm 16.54" x 6.57" x 6.02"

TRANSFORMERS

TR200 & TR400 TRANSFORMERS

Using Illumicare's transformers to install energy efficient, environmentally-friendly, LED landscape lighting gives you the option to use a smaller transformers and less wire, so you are free to build a system that can grow with your landscape.

- Built-in Digital Astro Timer
- Terminal blocks use lever-nuts, requiring **NO TOOLS**



Part Number	TR200-1215	TR400-1215
Input	120V AC 50/60Hz	120V AC 50/60Hz
Output	12/15V AC 200VA (200W)	12/15V AC2 x 200VA (200W)
Construction	Stainless Steel	Stainless Steel
Weight	14lbs	26lbs
Dimensions	11.8 x 4.7 x 4.7" / 300 mm x 119 mm x 119 mm (height=13.4"/34cm including mounting tabs)	16.4 x 4.8 x 4.8" / 120 x 120mm (height=18"/45cm including mounting tabs)

PURCELL | 100 WATT, MAGNETIC 12V TRANSFORMER



For small landscape lighting projects that require only a few fixtures, use Illumicare's discreet, single-tap 100W transformer, Purcell.

Ideal for short wire runs to light a few clustered fixtures, or hardscape luminaires, Purcell offers one 12V wire tap, a manual 4 to 8 hour timer with an on and off switch, and a built-in photocell.

Input	120V~60Hz
Output	100W
Operating Temp.	-10° to 40° C
Includes	Photocell & Manual Timer
Input Cable	36" 18AWG/2C 105°C
Dimensions	160 mm x 107.5 mm x 92 mm / 6.30" x 4.23" x 3.62"



E181950
5G45



LED DIMMER



The LED Dimmer provides 12 VAC dimming for up to 8A (100 Watts @12VAC). The dimmer may be mounted next to the 12 VAC transformer or anywhere inline. It is compatible with all Illumicare dimmable LED lamps and fixtures.

Specifications

- Wattage: 100W
- Operating Range: 12 VAC
- Capacity: 8 Amps
- Minimum Load: None
- IP: 63

5 YEAR
Warranty

DIGITAL ASTRO TIMER



The simplest way to control your outdoor lighting with the flexibility that meets your needs. With 4 modes of control to choose from, the DIGITAL ASTRO TIMER works with any standard outlet and is compact enough to easily fit your low voltage lighting transformer.

Specifications

- 120V AC 60Hz
- 15A (Resistive)
- -20 - 50°
- 80.5 x 71.5 x 60 mm

2 YEAR
Warranty

PHOTOCELL



Control street, passage, and doorway lighting automatically in accordance with the ambient lighting level.







Specifications

- Time delay 30 -120 seconds
- Temperature compensated
- Swivel incorporated
- 1.5VA, 120V AC, 50/60Hz
- 1800W Tungsten / 1100VA Ballast
- 10-20Lx - On (Dusk) / 30-60Lx - Off (Dawn)

2 YEAR
Warranty

ACCESSORIES

MOUNTS, STAKES & STEM EXTENSIONS

	Brass Surface Mount - 4" Width
	Brass Stake - 7" Length
	Plastic Stake - 9" Length
	Extendable Stem 20" to 32"
	12" Stem Extension
	18" Stem Extension
	24" Stem Extension

LOW VOLTAGE 12 & 14 GAUGE WIRE



- Designed for low voltage landscape lighting
- UL listed - meets Canadian & US requirements
- UV resistant for long life
- Listed for outdoor use
- Flexible insulation sheath
- Suitable for direct burial applications

Part Number	Description
W 14/2-50	14 AWG, 2-conduit, 50'
W 14/2-100	14 AWG, 2-conduit, 100'
W 14/2-250	14 AWG, 2-conduit, 250'
W 12/2-100	12 AWG, 2-conduit, 100'
W 12/2-250	12 AWG, 2-conduit, 250'
W 12/2-500	12 AWG, 2-conduit, 500'

LIGHTING SAMPLE KITS | THE ULTIMATE SALES TOOL FOR LIGHTING PROFESSIONALS



2

Why buy each fixture and lamp individually to build your own showcase when you can purchase an entire set, combined in a custom carrying case for more than 60% off the regular price!

These convenient kits were developed to assist you in demonstrating the quality and durability of professional grade fixtures and lamps in the early stages of your sales process.



1

Lighting Sample Kit - features 13 solid brass fixtures & 13 LED lamps, including our most popular miniatures and MR16s of various colors and beamspreads.

Lighting Sample Kit 2 - includes 3 copper & SS fixtures from our Precision line, 3 hardscape luminaires, plus copper & brass coping lights, our most popular miniature LEDs and MR11 & MR16 lamps with replaceable optics.



Naturally blending into the landscape, Jaspers provide dramatic effects and welcoming light upon friendly creatures in the Children's Garden.

WARRANTY

Illumicare Group Limited's products are guaranteed to the original owner against defects in material and workmanship. Free of charge, Illumicare Group Limited will replace any properly installed lamp, fixture, luminaire or transformer which fails under normal operating conditions and has not undergone abuse beyond normal wear-and-tear within the specified warranty period.

Damage due to physical abuse, tampering, improper installation, acts of nature such as but not limited to lightning strikes, hurricanes, tornadoes, earthquakes and floods will not be covered under the warranty.

Series	Product	Warranty Period
LED Lamps	MR16, MR11	5 Years
Miniature LED Lamps	G4, G5.3, SCB, S8, T5, BP Rear, BP Side	5 Years
Professional Grade Solid Brass Fixtures	Jasper, Woody, Sandy, Brook, Wally, Heidi, Declan, Ginger, Opal, Herb, Roxy, Misty, Aspen, Pearl, Bentley, Rowan, Sierra, Laurel, Clay.	Lifetime
Precision Engineered Luminaires	Artemis SS & Copper), Erebus (SS & Copper), Asteria (SS & Copper), Leto, Alder, Orion, Demeter, Helios, Adonis (SS & Copper), Aphrodite (SS & Copper), Nyx (SS & Copper), Eros (SS & Copper), Proteus and Proteus SS	Lifetime
Integrated LED Coping Luminaires	Cliff, Phoebe SS & Phoebe Copper (including MINIs)	10 Years
In-Ground Luminaires	Evie, Astrid, Nova	5 Years
Hardscape Symphony Luminaires	Brahms 1, Brahms 2, Brahms 3, Mozart, Chopin, Haydn, Vivaldi	2 Years
Aluminum Fixtures	The Shadow, Silhouette, Profile	7 Years
Multi-tap Transformers	TR75-1215, TR150-1215, TR200-1215, TR300-1215, TR400-1215, TR600-1215	Lifetime
Single-tap Transformer	Purcell	2 Years
Photocell / Digital Timer	Photocell and Digital Astro Timer	2 Years
LED Dimmer	LED Dimmer	5 Years
Smart Home	WiFi Smart Socket, Outdoor WiFi Smart Socket, Merlin TX, RX, Hub	2 Years

A Return Merchandise Authorization (RMA) must be issued by Illumicare prior to the return of any product.

Illumicare Group Limited is not liable for any indirect, incidental, or consequential damages in connection with use of equipment, including but not limited to damage or injury to vegetation, property or persons resulting from installers' actions whether negligent or otherwise.

Illumicare Group Limited does not provided compensation for transportation, labor or any other charges incurred in the diagnosis, repair or replacement of our lamps, fixtures, luminaires, accessories or transformers.

Installers are encouraged to contact Illumicare Group Limited directly to help diagnose problems before requesting warranty replacement. For more information about warranty, please contact: sales@illumicaregroup.com. **Specifications within this catalogue may change without notice.



LIGHTING DESIGN Credits



Bold Lighting

Inside Front Cover



Commonwealth Landscape Lighting

Feature photos – p. 11, 35



Groundhog Landscaping / Eco Springs Irrigation

Back cover photo

Lighting effects – p. 4-5,

Feature photos – p. 31, 45



Hill'n Dale Landscaping

Lighting effects - p. 4-5

Feature photos - p. 21, 39, 40, 47



Island Villa Lighting

Feature photos – p. 29, 33, 37



Knight Eclairage

Front cover photo

Lighting effects - p. 4-5

Feature photos - p. 9, 17, 25, 34, 46



OGS Green Turf Irrigation Systems

Lighting effects - p. 4-5

Feature photos - p. 13, 15, 21, 38



Shademaster Luxury Landscapes / Luxury Light Outdoor Systems

Lighting effects - p. 4-5

Feature photo - p. 6



INNOVATE | INTEGRATE | ILLUMINATE



PROUD MEMBER OF:



Newmarket ON CANADA L3Y 7B6
P 1-866-277-2934 | F 1-800-559-1806
illumicaregroup.com
sales@illumicaregroup.com

© Copyright Illumicare Group Limited